

# Data Sheet



Article number: 250302200625

Description: Kleedrive T3C 200L2-6 22.0KW 900 rpm  
3x400/690V 50HZ IP55 B14 Eff=92,2%

## Measures

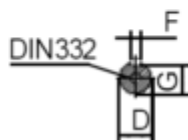
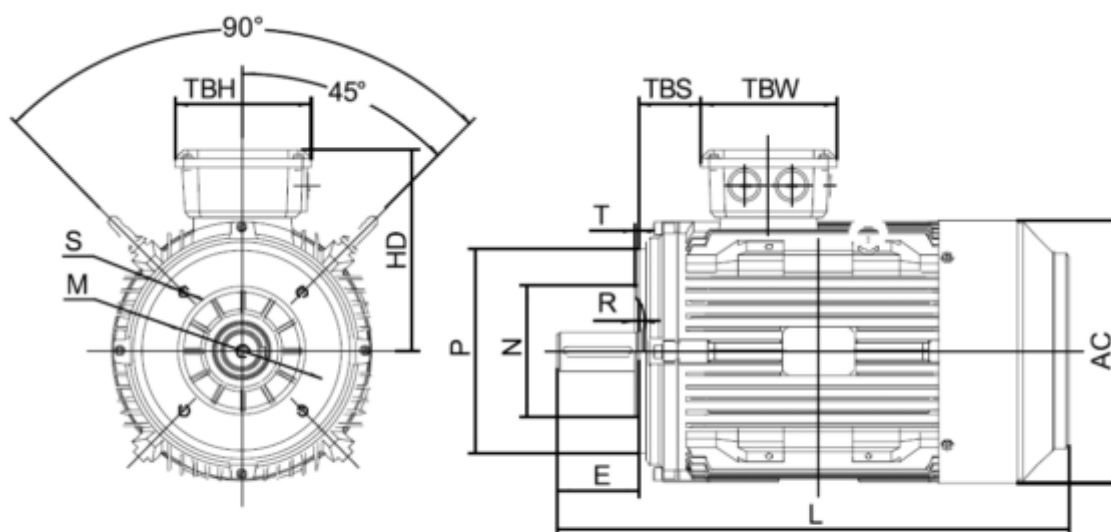

AA = 393	K = Ø19	TBW = 186
AC = Ø399	L = 768.5	
AD = 500	M =	
D = Ø55	N =	
E = 110	P =	
F = 16	S =	
G = 49	TBH = 233	
HD = 300	TBS = 192	